

2023



Race Regulations

Version: 2023/2

Approved by:

Niall Taaffe (TKC Chairperson)

Date: 8th March 2023

Tullyallen Kart Club reserves the right to update this regulation book as required. Competitors will be notified of any changes.

Contents

1. Introduction	4
2. Acquaintance with and Submission to the Regulations	4
3. Fees & Membership	4
4. Insurance	4
5. Kart Classes & Minimum Weights	5
6. Championships.....	5
7. Race Officials.....	6
8. Flag Signals.....	7
9. Race Entries	7
10. Driver’s Briefing	7
11. Scrutineering.....	7
12. Safety Re-Scrutineering.....	8
13. Rules on Inspection	8
14. Tyres	9
15. Protective Clothing.....	10
16. Consumption of Alcohol/Drugs.....	10
17. Paddock	10
18. Access onto Track / Dummy Grid / Parc Ferme Area	11
19. Novice Drivers.....	11
20. Practice and Grid Selection for Heat 1 & 2	12
21. Format of Grids for the Final.....	12
22. Dummy Grid Formation	12
23. Starting.....	13
24. Race Stoppage.....	14
25. During the Race.....	14
26. Penalties	15
27. Complaints Procedure.....	15
28. Technical Specifications	16
28.1 General	16
28.2 Kart	16
28.3 Engine.....	18
Appendix A - Karting Flags	20
Appendix B - Tyre Specifications.....	21
Appendix C - Example Offences and Subsequent Penalties	22
Appendix D – Kart Class Information	24

Bambino Comer	24
Bambino IAME	24
Restricted Cadet	24
IAME Cadet	25
Junior Max	25
Junior IAME X30.....	25
Senior IAME X30	26
Rotax Senior Max (165)	26
Rotax Senior Max (180)	26
Gearbox / 125 KZ2	26
Super Pro	27
Appendix E – TKC Number Plate Regulations	28
Appendix F – Front Fairing, Technical Drawing 2c	29
Appendix G: T-Plate Supplementary Regulations:	30

1. Introduction

The objective of these regulations is to ensure that Tullyallen Karting Club (TKC) events are carried out in a manner which ensures the safety of competitors and Officials, and which encourages the sport to be competitive and fair for all who take part. To this end, TKC operates to a clubman specification.

TKC makes no pretence of having designed a fool-proof set of race regulations. Consequently, these rules and regulations will be periodically reviewed towards safer and fairer competition for all. TKC organised testing days are also subject to all applicable sections of these regulations.

A key rule to remember when reading these Race Regulations is that **“If it doesn’t say you can, then assume that you can’t”**.

All enquiries regarding these regulations should be directed towards the CoC or the Chairperson.

2. Acquaintance with and Submission to the Regulations

By the mere fact of entering a TKC event, every participant agrees to abide by these regulations (including any supplementary regulations or instructions relating to that event), and above all comply with the instructions, guidance and rulings provided by the Committee, CoC and Officials.

Every person, taking part in a TKC event will be deemed to have, and be recognised as having:

- (a) Made themselves thoroughly acquainted with these Regulations, TKC’s COVID-19 Policy & Guidelines and any supplementary rules or instructions that may be in force for a race meeting.
- (b) Submitted themselves without reservation to the consequences resulting from these Regulations and any subsequent alteration thereof.

The Officials at any TKC race meeting will exercise, their powers throughout the entire race meeting.

Drivers will at all times be responsible for the conduct of their pit crews, and any offence committed by a crew member will be chargeable directly to the competitor. The parents, guardians and associates of drivers in the paddock area are classed as pit crew members.

3. Fees & Membership

All participants in a TKC event must be fully paid up members of the Club. Club membership is for the duration of the TKC 2023 championship and for the TKC 2023 T-Plate. Entry requests for participation in a TKC event will be rejected where all fees due to the Club have not been paid.

TKC reserves the right to reject any request for membership, or where it feels appropriate, terminate the membership of any member, without giving any reason whatsoever.

Any member that has been suspended, or has had their membership revoked, because of a penalty, general misconduct or any other breach of these Regulations, is not entitled to any form of reimbursement of their membership fee.

All drivers must register as competitors by completing the registration process online via Alpha timing <https://tkc.alphatiming.co.uk/register/series> with the appropriate fee being paid upon checkout. Membership is not valid until TKC receives both fully completed membership form and fee. Registration and payment does not confirm acceptance of membership.

4. Insurance

All race participants are required to take out personal accident insurance which has been organised by the Club and is included in the entry fee for each race meeting entered. Competitors should note that the insurance policy in place

provides a basic level of insurance cover. Competitors should therefore review the level of cover provided against their needs and take out additional insurance cover if required.

5. Kart Classes & Minimum Weights

Class	Minimum Combined Kart/Driver Weight	Age
Bambino (Comer)	71kg	5 – 8
Bambino (IAME)	74kg	6 – 8
Restricted IAME Cadet	95kg	8 – 10
IAME Cadet	105kg	8 – 12
Junior Max	148kg	12 - 16
Junior IAME x30	145kg	11 – 15
Senior IAME x30	161kg	15 +
Rotax Senior Max (165)	165kg	15 +
Rotax Senior Max (180)	180kg	16 +
125 KZ2 (Gearbox)	180kg	15 +
Super Pro	195kg	16+

Note:

As regards the upper age ranges a competitor may finish the championship in that class once they were below the upper age limit at the date of the first round of the championship.

TKC may ask to see a birth certificate / passport to verify a member's age. Refusal to provide proof of date of birth will result in withdrawal of membership. Entering into a class you are not eligible for may result in the revoking of your membership.

6. Championships

For all TKC Championship series the following rules and regulations apply:

- (a) Championship will typically consist of 8 rounds, 6 of which will be scoring rounds, with the remaining 2 being dropped rounds.
- (b) Should it become necessary to reduce the total number of rounds in a Championship, for whatever reason, drivers will be informed, and the following adjustments will be made to the dropped rounds:
 - 7 round Championship: 6 scoring rounds, with the remaining 1 being dropped.
 - 6 round Championship: 6 scoring rounds, with no round dropped.
- (c) Should a driver be disqualified from a heat or final, or be excluded from participating in a race as a result of a penalty, then that race will have a score of zero and that round will be classified as scoring round.
- (d) Should a driver be disqualified from a round, or be excluded from participating in a round, as a result of a penalty then that round will have a score of zero and will be classified as a scoring round.
- (e) In the event that a competitor wishes to make a complaint regarding their allocated points they must contact TKC via email tkartclub@gmail.com within 7 days of the points being updated and issued .
- (f) In the event of a tie for the Championship the winner will be decided upon based on the greatest number of first place finishes in his/her championship counting finals. Should this still result in a tie then the winner will be decided upon based on the greatest number of second place finishes in his / her championship counting finals and so on.
- (g) Once upgraded to a senior class a competitor may not revert to a junior class.

- (h) A competitor must compete in at least 4 rounds / events to qualify for Championship prizes.
- (i) A minimum of 3 drivers must complete 4 rounds in a class in order for Championship prizes to be awarded for that class.
- (j) Points will be awarded as follows:

Placing	Heats 1 & 2	Final
1 st	20	40
2 nd	17	35
3 rd	15	32
4 th	13	29
5 th	12	26
6 th	11	24
7 th	10	22
8 th	9	20
9 th	8	18
10 th	7	16
11 th	6	14
12 th	5	12
13 th	4	10
14 th	3	8
15 th	2	6
16 th	1	4

7. Race Officials

The senior Officials (the "Officials") of a race meeting are the Clerk of the Course (CoC) and his assistant CoC(s). The Officials have the authority to enforce compliance with the Club Regulations (including any Supplementary Regulations), and to adjudicate upon certain disputes or complaints that arise during the meeting. They shall have the power to perform duties that include, but are not limited to, the following:

- (a) Decide what penalties to apply for breaches of these Regulations.
- (b) Prior to the race meeting, assist in the preparation or amendment of any Supplementary Regulations as deemed necessary.
- (c) Prohibit from competing any driver who, or any kart which, they consider to be dangerous, or is reported as such by the Scrutineers.
- (d) Exclude any driver from one or more heat/final, or for the duration of the meeting, whom they consider to be ineligible to take part or whom they consider guilty of misbehaviour, unfair practice or deem to be driving dangerously.
- (e) Penalise any driver who refuses to obey the order of a race Official.
- (f) Postpone or alter the conditions of a heat, final or entire event for reasons of safety or "force majeure."
- (g) Classify the race as either dry, wet or open, based on current weather conditions.
- (h) Modify the track layout or alter the event programme where necessary to ensure reasonable safety for drivers.
- (i) Alter the composition of, or consolidate, the heats.
- (j) Alter (increase or reduce) the original specified race distance.
- (k) Appoint a temporary substitute or substitutes to replace any Officials or Marshals not able to perform their duties.

- (l) Approve the commencement of the practice and competition sessions.
- (m) In extraordinary circumstances, take the decision to stop or abandon an event.
- (n) Settle any issue which might arise during a race meeting, in accordance with the Club Regulations.
- (o) Deal with the misbehaviour of, or breach of regulations by, a driver or his/her pit crew.

Notes: All Officials and Marshals shall be aged 16 or over, all of whom will sign on before commencing their duties. Only signed on race Officials and Marshals are permitted on the track at any time.

8. Flag Signals

Flags that will be used during the event are set out in Appendix A along with a description of their meaning. Drivers must make themselves familiar with the flags in use.

Flag signals given by Officials and track Marshals must be obeyed at all times. Failure to do so will result in a penalty (see 'Penalties' section, Appendix C).

9. Race Entries

All race entries must be provided online via the links provided on the TKC website. The deadline for registration for each meeting will be indicated on the website. **A €50 administration fee will be charged for the following:**

- (a) Late online entries (entries received after closing date but before the allocated cut-off time. No entries will be accepted after the allocated cut-off time).
- (b) no entries allowed on morning of the event at present.
- (c) Competitors not completing scrutiny, online sign on and check in the day before the race.

An entry withdrawn before the closing date will receive a full refund. An entry withdrawn by 9pm the night before a race will receive a refund less a €20 administration fee. An entry withdrawn after 9pm the night before a race will not receive a refund.

The minimum number of entries per class per event will be five. If this number is not reached we will notify entrants on the Monday night before the event to inform them the class is not going to run and all class entries will be refunded.

10. Driver's Briefing

- (a) A Driver's Briefing will be held prior to commencement of racing and all drivers must attend.
- (b) A roll call may be held at the briefing to confirm attendance (at the discretion of the CoC).
- (c) Failure to attend the driver's briefing will result in the driver not being allowed on track until such time as the driver has been briefed by the CoC or an appointee of the CoC.
- (d) Any driver found to have entered the track without attending driver's briefing or without separately being briefed by the CoC or an appointee of the CoC will be disqualified from the event.

11. Scrutineering

The purpose of scrutineering is to ensure that the kart and apparel in which a driver intends to compete (or has competed in) has complied with the requirements of the Club Regulations.

- (a) It is the competitor's responsibility to complete the online scrutineering form before 8am on race day. No changes will be permitted to the submitted information after this time. It is the competitor's responsibility to ensure all information on the online scrutiny form is correct as incorrect information will result in penalties being issued.

- (b) All competitors are required to present their kart (1 x chassis permitted per day) on a suitable trolley, 1 x set of race tyres that will be used for the day, full race apparel (race suit, helmet, gloves, boots, neck brace, rib protector) for acceptance prior to the start of the meeting. The kart must also display correct number plates with correct class colours (See Appendix E). The kart must only be presented in a "race ready" condition.
- (c) All karts entered in any event must be scrutineered before being permitted to take part in any practice session, or race. (Subject to CoC's discretion on race day).
- (d) If the scrutineer reports that a driver or kart should be excluded from any meeting or section of the meeting on safety grounds, then the driver may lodge a complaint on that decision (see 'Complaints Procedure' Section 27).
- (e) A kart which has not passed scrutineering on the decision of the Scrutineer or the Officials cannot take part in the meeting until the issue has been resolved.
- (f) The sole responsibility for the safety of the kart and its adherence to the Regulations is that of the competitor, not the scrutineer, who has absolutely no responsibility in this regard.
- (g) Each kart will have affixed to it a correct scrutineering tag supplied for that meeting. This signifies that the driver has completed a Scrutineering Form relevant to their entry and has passed all required scrutineering checks. The Grid Marshals shall not allow any kart to enter the track that does not display a correct scrutineering tag. It is the competitor's responsibility to ensure they display the scrutineering tag before coming to the grid. (Subject to CoC's discretion on race day).
- (h) At any time during the event, if the equipment being used, including the chassis, tyre numbers and engine numbers do not conform in all respects to the data on the scrutineering document, the driver will be excluded from the relevant heat or final.

12. Safety Re-Scrutineering

- (a) Karts that incur damage due to an accident during practice or racing must be presented for examination to the scrutineers prior to re-entering the track. Failure to do so will result in a penalty (see 'Penalties' section, Appendix C).
- (b) Replacement of a chassis may be permitted, if after inspection by the Scrutineers it is deemed that the damage to the original chassis cannot be repaired in the time available, prior to next section of the meeting. The replacement chassis must be scrutineered for compliance prior to being allowed on track.

13. Rules on Inspection

- (a) A kart or a driver may be inspected at any time throughout the duration of the race meeting.
- (b) If a kart or apparel is not submitted immediately for inspection, when requested at any time by the CoC or TKC Official, the kart and the driver are automatically disqualified from the meeting and will forfeit all place positions or points already gained at that meeting.
- (c) If a kart fails inspection after any section of the meeting, it is not a defence to claim that the kart and driver had passed scrutineering.

- (d) An Official or Scrutineer may mark any engine part, tyres, accessory or item of apparel and require it to be presented at the end of the meeting for further inspection . If the driver doesn't present the item for inspection they are automatically disqualified from the meeting and will forfeit all place positions or points already gained at that meeting.
- (e) Fuel samples may be taken as required for testing to monitor compliance requirements i.e. the use of standard pump fuel (95 octane) and the appropriate 2 stroke oil mix if required. Addition of any performance enhancing chemicals is strictly forbidden.

14. Tyres

- (a) The tyre specifications that may be used in each class are displayed in Appendix B.
- (b) Competitors must use the prescribed dry weather tyres (see Appendix B), unless the track conditions are declared wet by the CoC, at which time they will be required to run the prescribed wet weather tyre (see Appendix B).
- (c) In intermediate track conditions the CoC may classify the tyre choice as 'Open', at which time the driver may choose to run either wet or dry tyres.
- (d) It is not permitted to use a mix of wet and dry tyres. Likewise, should more than one type of tyre be allowed for a class, it is not permitted to mix tyre types (e.g. you cannot have a set of tyres consisting of Mojo's and Vega's).
- (e) For all classes at all times the rear bumper must not exceed the overall width measured to the outside of the rear wheels or tyres (whichever is greater), and the side pods may not be located outside of the plane passing through the outer edge of the rear wheel or tyre (whichever is greater). The rear bumper must cover at least 50% of each wheel / tyre at any time.
- (f) The use of remould tyres is not permitted.
- (g) Processes such as the chemical treatment of tyres or the heating of tyres for the purpose of gaining performance is not permitted and will be penalised. Tyres may be checked by the scrutineers using a MiniRAE Lite detector calibrated for Isobutylene at 100ppm. Any reading above 4ppm within 5mm of the surface of the tyre will be deemed to contravene the regulation and will result in disqualification from the event.
- (h) The minimum tyre tread depth for Bambino Comer is 1mm at any point across the tyre or at any point picked by the scrutineer.
- (i) The barcodes of all tyres that you intend to use at an event must be registered before online scrutiny closes. If the tyres being used during any part of the event have not been registered prior to the scrutiny deadline, or do not conform to those registered to that competitor at pre-race scrutiny for that event, that competitor will be disqualified from the relevant race.
- (j) If a tyre is damaged beyond use it may be replaced at the discretion of the scrutineer. The damaged tyre must be reported to the scrutineer before leaving parc ferme and must be replaced with a tyre of equal wear and the barcode of the replacement tyre must be given to the scrutineer.

15. Protective Clothing

- (a) Safety helmets: it is compulsory for competitors to wear a full-face helmet with a snap down visor. Straps are to be free of abrasion wear and fraying and must be secured on the head with a double d ring fastener. Visors must be free from excessive scratches offering clear and unrestricted vision. Scrutineers' opinion will be taken as matter of fact. Visor colour and tint is permitted including iridium. However, in the interest of safety TKC may call for clear visors to be fitted on occasion of low or diminishing light. Helmets classified to the following standards may be used:
- British Standard BS 6658:1985
 - UNECE Regulation 22.05
 - Any standard accepted by a member of the European Economic Area which offers a level of safety and protection equivalent to BS 6658:1985 or UNECE Regulation 22.05
- (b) Race Suits: A one-piece multi-layer and abrasion resistant race suit with full length sleeves and trouser legs that is adequately secured at the neck, wrists and ankles. Must be free from cuts and abrasions and adequately cover the legs / arms.
- (c) Footwear: Securely fastened race boots must be worn to cover and protect the ankles (no loose laces or straps).
- (d) Gloves: Gloves, to the satisfaction of the Scrutineers, with full-fingered protection must be worn by all drivers.
- (e) Rib Protectors: The use of rib protectors is mandatory for all drivers They must be free from abrasion and loose straps that could impinge on the safe operation of the kart.
- (f) Neck Braces: The use of neck braces is mandatory for all Bambinos and strongly recommended for Cadets. They must be free from abrasion and loose straps that could impinge on the safe operation of the kart.
- (g) Wet Weather Clothing: Wet-weather clothing may be worn over approved protective clothing during wet conditions. Hoods, if fitted, must be secured inside the garment.

Note: It is dangerous and an offence for a driver to carry any weights in his/her clothing or on their person.

16. Consumption of Alcohol/Drugs

- (a) Consumption of alcoholic beverages in the paddock or any other part of the meeting venue, which is under the control of the Officials, is strictly forbidden.
- (b) Any driver or crew member who is considered to have consumed any alcoholic beverage on the day of the meeting shall not be permitted to participate.
- (c) A driver or crew member who, in the opinion of the Officials, is affected by alcohol, medication, drugs or who displays any other sign of physical or mental impairment shall be excluded from the meeting.
- (d) A driver or crew member may at any time be tested for the consumption of alcohol.

17. Paddock

- (a) It is forbidden to drive a kart inside the boundaries of the paddock area for any reason whatsoever.
- (b) Fuel is to be stored in appropriate containers and kart engines are to be stopped before refuelling.
- (c) When necessary, Officials or Marshals will provide competitors with designated parking areas for their support vehicles in the paddock area. Failure to adhere to such instruction will result in the competitor being excluded from the meeting.

- (d) Toys, bicycles, footballs etc. will not be permitted in the paddock.
- (e) Standing on top of any vehicle, or vehicle tailgate or other portable raised platform for spectating or other purposes is not permitted at the track during race day. The penalty for breach of this rule is exclusion of the driver / entire team and any other driver associated in any manner with those involved in the breach from the event.

18. Access onto Track / Dummy Grid / Parc Ferme Area

Access onto the track / dummy grid / parc ferme area at any time is limited to the following:

- (a) Competitors, Race Officials and Marshals that are signed on and wearing a high visibility vest.
- (b) Parents / Guardians / Mechanics of Bambino drivers will only be permitted on track once they have signed TKC's indemnity form, are wearing an appropriate hi-viz vest and are positioned at a marshal post. If you are not standing at a marshal post your child will be disqualified from that race. If you are found to be filming a race while on track your child will be disqualified from that race.
Parents / Guardians / Mechanics of Cadets or Juniors are no longer permitted on track. If you enter the track without the permission of a marshal / COC your child will be disqualified from that race.
- (c) Anyone wishing to access track on race day to take photos must register with TKC at least 1 week prior to the race day. When they register and complete their Garda Vetting they will be issued with a numbered Bib to use on race day. They will also have to agree to supply photos for the club to use on social media. Only authorised race photographers, who have been Garda Vetted for TKC, have signed on and registered with TKC and are wearing their numbered bib will be allowed onto the track.
- (d) At no times is it permitted to allow a child access to the scrutiny area / shed. Anyone found to be in the scrutiny area / parc ferme area without the permission of the CoC / Scrutineer will receive a 3 place penalty. Parents / Mechanics must not enter this area without permission.
- (e) Access to the Dummy Grid is restricted to driver and one mechanic only. No one else is permitted into the Dummy Grid Area.

Note: No other person is allowed access onto the track / dummy grid / parc ferme area without the specific permission or invitation from the CoC or Officials. A breach of this regulation will result in the driver being penalised (see 'Penalties' section, Appendix C).

19. Novice Drivers

A novice driver is generally any driver who is new to the sport of kart racing.

If you have already completed a minimum of 6 races in any class with TKC, and / or another karting body (to be determined by the Committee), you do not hold novice status. However, if a parent / guardian wishes to continue to run their child on black plates on safety grounds they must confirm this with the CoC or Committee in advance of a race. There is no novice championship.

All novice drivers must make themselves known as a novice on their race entry and on the morning of the race to the sign-on Official. All novice drivers must wear black number plates with white numbers and must also wear a high visibility armband for the duration of 6 TKC Championship rounds.

See Section 20 (b) for details on grid positions for novice drivers.

TKC reserve the right to return a driver to novice status on safety grounds.

20. Practice and Grid Selection for Heat 1 & 2

- (a) During practice sessions the performance of all new or inexperienced drivers will be monitored by the race Officials.
- (b) To establish grid positions for heats 1 and 2, normal practice will be to apply a randomised selection process to the list of competitors entered in each class. The grid for heat 2 will be the reverse of the randomised order for heat 1. All competitors will be allocated time for a free practice session prior to commencement of the heats.
- (c) Where a serious offence has occurred the CoC may decide to exclude the competitor from taking part in Heat 2, or possibly any other part of the meeting.
- (d) Novice drivers are required to take up positions at the back of the heat 1 and 2 grids, these drivers will be removed from the list before randomisation takes place. Novice drivers can however take up their calculated grid positions for the final based on their combined score from the two heats. The competitor may still start at the back of the grid for the final if they wish.

21. Format of Grids for the Final

- (a) Grid positions for the final will be determined based on lowest combined points scores from Heats 1 and 2. The driver with the lowest points score will be on pole position and so on. Where two or more drivers have the same points score, they will be placed on the grid in order of their fastest lap in Heat 1.
- (b) Points for both Heats will be allocated as follows: 1st Position - 0 Points, 2nd Position - 1 Point, 3rd Position - 2 Points, and so on.
- (c) Any competitor not finishing a Heat, for whatever reason, will be given a score equal to the total number of drivers completing the heat, plus 1.
- (d) Any competitor not starting a Heat, for whatever reason, will be given a score equal to the total number of drivers completing the heat, plus 1.
- (e) Any competitor disqualified from a Heat, for whatever reason, will be given a score equal to the total number of drivers completing the heat, plus 5.

22. Dummy Grid Formation

- (a) The Grid Marshals will call all competitors to the grid. Everyone from that class must immediately make their way to the dummy grid. Karts must be in a "race ready" condition before entering the dummy grid. The Dummy grid will close as soon as the last kart, from the previous race, leave the track and no competitors will be allowed into the dummy grid or onto the track after this point.
- (b) In the event of a grid position(s) being left open the position(s) will be filled by the next placed competitor(s), and the offending driver(s) will be positioned at the back of the grid in the order of their arrival at the discretion of race Officials/personnel.

- (c) All novice drivers will be positioned at the rear of the grid and will wear high visibility armbands whilst competing in all heats, but may take up their appropriate position in the final, based on their total points scored during the heats if they so choose.
- (d) All karts will be checked on the dummy grid for correct marked tyres, drop down bumper, scrutiny tag.
- (e) A kart shall not be started in the dummy grid area whilst on a trolley and shall not be lifted while the engine is running. Anyone found to be in breach of this rule will be moved to the back of the grid.
- (f) In the Bambino and Cadet classes, the practice of lifting the rear of the kart whilst the engine is running is strictly forbidden under any circumstances. Anyone found to be in breach of this rule will be moved to the back of the grid.
- (g) Under no circumstances can a kart be refuelled on the dummy grid.
- (h) Karts will be released from the dummy grid area by the Grid Marshals, under the instruction of the CoC, at which time they are under Starters orders.
- (i) A kart failing to leave the grid area in formation may then only join the back of the formation during the warmup lap, if they are able and are permitted to do so by the CoC. **TAKING A SHORTCUT THROUGH THE TRACK TO CATCH THE PACK IS FORBIDDEN AND WILL RESULT IN DISQUALIFICATION.**
- (j) On completion of the formation lap access to the track will be closed. A kart that enters the pit/paddock area during the race (i.e. leaves the track) will not be allowed to re-join the race.
- (k) Should a competitor decide NOT to compete in a section of the meeting for which they have entered, for whatever reason, they must immediately notify the Grid Marshals, who will in turn notify all relevant Officials.
- (l) In the case of multiple classes being run in the same race, separate grids will be formed and will be started at an interval deemed safe by the CoC.

23. Starting

- (a) A rolling start procedure will be used for all races unless otherwise stated by CoC at driver's briefing. A standing start will be used for Bambino class.
- (b) During the formation lap drivers must maintain their grid position until the race has been started in accordance with items f-h below. Drivers failing to comply with this regulation will incur a penalty. (see 'Penalties' section, Appendix C).
- (c) The field will complete approximately one full formation lap before the start signal will be given. Any change to the number of formation laps will be communicated to the drivers.
- (d) All drivers must be in their correct position before reaching the last marshal post before the start line. If a driver is observed by the CoC to be out of position, a penalty will be applied.
- (e) The driver on pole position, under direction of the Starter and CoC, shall control the speed at which all drivers approach the start/finish line in anticipation of a start signal.
- (f) The two rows of karts shall approach the start/finish line at a slow speed and in a tight grid formation.
- (g) As soon as the Starter/CoC is satisfied with the formation, they will raise the starting flag (Green Flag) to start the race. It is forbidden for drivers to accelerate until the front row of karts has accelerated.
- (h) All karts must remain within the tramlines until Green flag is raised.
- (i) In the event that the Starter is not satisfied with the formation when they approach the start/finish line, they will indicate that a further formation lap is required by rotating their hand in a circular motion above their head.
- (j) In the event of karts breaking formation before the start of a race the CoC may elect to either:

- Stop the race and apply a grid placement penalty to the offending driver or drivers,
Or
- Allow the race to continue and may apply a penalty to the offending driver or drivers at the completion of the race. A complaint may not be made against this decision.

24. Race Stoppage

- (a) Races will only be stopped in the event of an emergency situation, which will be indicated by the use of red flags by the Track Marshals.
 - (b) When a race is stopped it will be restarted over the remaining number of laps, unless 75% of the race distance has been completed, in which case the finishing order will be as per the running order at the end of the last lap prior to the race stoppage.
 - (c) Any competitor who has retired due to mechanical failure or is more than one lap down on the leader when the red flag is used to stop a race will not be permitted to re-enter the race at the restart, following resolution of the incident. There shall be no complaint made against this decision.
 - (d) After a Red flag incident, karts will be under “parc-ferme” conditions and no work on them will be permitted. Front bumpers may be reset in the event of a full restart being declared only with the permission of the CoC.
 - (e) Any karts identified by the Scrutineers to be unsafe and/or non-compliant with these regulations will be excluded from the re-start of the race. Drivers involved in a racing incident may also be asked by the Officials to undergo a medical examination prior to being allowed to re-join the race.
 - (f) Karts re-joining the race, which were involved in the incident, will be positioned at the rear of the formation at the restart.
 - (g) The restart procedure for the race will be as follows:
 - In the event of a first lap stoppage, the race will be restarted in the original grid order formation; after all ineligible karts have been excluded, in accordance with items (f) and (g) above.
- Or
- The grid order will be as per the race order at the commencement of the lap on which the race was stopped.

25. During the Race

- (a) **Kart racing is strictly a non-contact sport.** A driver who drives or acts in a manner that could endanger themselves or any other persons will be penalised at the discretion of the CoC (see ‘Penalties’ section, Appendix C).
- (b) A driver causing a kart to make contact with another kart, in an incident that was deemed to be avoidable by the Officials, will be penalised at the discretion of the CoC (see ‘Penalties’ section).
- (c) Manoeuvres liable to hinder other drivers, such as weaving or premature direction changes, intentionally forcing a kart towards the inner or outer edge of the track or abnormal braking manoeuvres, are strictly prohibited and shall be penalised accordingly (see ‘Penalties’ section).
- (d) Any driving on track, deemed as careless or dangerous by the Officials, will be penalised (see ‘Penalties’ section, Appendix C).
- (e) When a kart is about to be overtaken by an approaching kart, the driver of the kart being overtaken must hold his/her normal racing line and allow the lapping kart to pass unimpeded and must at all times obey the blue flag signals given by the Track Marshals.
- (f) It is strictly forbidden to drive a kart in the opposite direction to that in which the event is being run.
- (g) Any kart that has left the track with all four wheels must not re-join the track until it is safe to do so.

- (h) It is forbidden for a kart that has left the track with all four wheels to re-join having gained a time or place advantage.
- (i) If a driver is forced to stop his/her kart on or near the track, for whatever reason, they must position it in such a manner as to cause the least danger or obstruction to other competitors.
- (j) The driver must then remain with their kart and move to a safe location, until the end of the session, and **must also keep their helmet on** until the race has been completed.
- (k) A driver that is given outside assistance at any point during the race will be disqualified from that section of the meeting. For Bambino and Cadet classes, the CoC may grant an exception to this rule at his sole and absolute discretion. For Junior Max, Mini Max & Junior x30 classes the only outside assistance permitted is assistance by a marshal (not a parent / guardian / mechanic) which is at the sole and absolute discretion of the CoC.
- (l) A kart must be driven over the finish line within 2 minutes of the race winner and have completed over 50% of the race distance to qualify for championship points.
- (m) The Chequered flag will be displayed at the end of all sessions.
- (n) When the chequered flag is displayed, regardless of whether or not a driver is on the same lap as the leader, racing is finished and all drivers must slow down and return to the paddock in a safe and controlled manner.

26. Penalties

The Officials of the meeting may impose a penalty consisting of one or more of the following types:

- a. Fine
- b. Grid position penalty
- c. Time penalty
- d. Placement penalty
- e. Points penalty
- f. Disqualification/exclusion from that section of the meeting
- g. Disqualification/exclusion from the meeting
- h. Multiple race ban
- i. Suspension from the Club
- j. Expulsion from the Club

A number of examples of offences and subsequent penalties that may be imposed by the race Officials, based on the requirements set out in these Regulations as presented in Appendix C. This list, however, is by no means exhaustive.

27. Complaints Procedure

- (a) All complaints must be directed to the designated Complaints Administrator, who will be identified at the drivers briefing before racing commences. Any complaints relating to a racing incident must be submitted to the Complaints Administrator no later than 30 minutes after the race/incident in question. Failure to do this within the given timeframe, the complaint will not be addressed.
- (b) All Complaints lodged at the race meeting must be made in writing on the correct form available from the Race Complaints Administrator. A fee of €100 must be paid when a complaint is lodged and will be returned to the complainant if the complaint is upheld. All complaints relating to heat 1 and 2 will be addressed by the CoC and at least 2 committee members during the lunch break. The person raising the complaint must make themselves available during this time to put their case forward if required
- (c) An entrant or driver may have a right to appeal a decision or penalty imposed by the CoC or Race Officials. Appeals must be presented in writing within 2 day of the event to the Complaints Administrator, accompanied by an

additional €50, which will be refunded if the ruling is in favour of the complainant. Appeals should be sent for the attention of the Complaints Officer, Tullyallen Karting Club at tkartclub@gmail.com where payment will also be arranged.

- (d) Anyone wishing to submit camera footage to support a complaint can do but only footage from an onboard camera such as a GoPro will be accepted (no footage taken trackside will be accepted).

28. Technical Specifications

28.1 General

- (a) All karts' chassis must be in a safe, useable, race condition approved each event by TKC scrutineers.
- (b) Tuning, modifications or alterations that are not in compliance with the above is strictly forbidden.
- (c) The list of technical specifications set out in these regulations is far from exhaustive. Therefore, if a competitor is in any doubt as to the compliance of their kart or equipment, or any tuning or modifications made thereto, they must contact the Head technical scrutineer for clarification.
- (d) The fact that a particular Class specific Technical Regulation has not been documented in these Regulations is no defence for a competitor who breaches the regulation. The competitor will still be subject to penalisation.
- (e) For additional details on Kart Class Information please see Appendix D.

28.2 Kart

28.2.1 Minimum Weight Limits

- (a) The minimum weight limit for each class of kart is displayed in the 'Kart Classes and Minimum Weights' Section 5 of these Regulations. This minimum weight limit is comprised of the combined weight of the driver (plus all apparel), kart and engine, with the kart in complete racing trim.
- (b) Minimum weight checks will be carried out at the end of practice sessions, heats and finals. All competitors are required to be weighed after each heat and after the final (Subject to CoC's discretion on race day). Driver must be seated in the kart when being weighed.

Any competitor failing to comply with this regulation will not qualify for points for that session.

No weight = no championship points

- (c) When requested, drivers must present themselves and their kart, in full race trim, for weighing.
- (d) It is not permissible to alter the weight of either the kart or driver in any way prior to being weighed.
- (e) If a kart and driver fail to meet the specified minimum weight, he/she will be given one more opportunity to be re-weighed. Re-weighing must be done immediately, and driver and kart must not leave parc-ferme at any time before this is complete.
- (f) Where a weight infringement has occurred, the driver will receive no points for that particular race.
- (g) The calibration status of the scales on the day is deemed to be correct and all subsequent weights recorded will therefore be absolute and final. It is the driver's responsibility to ensure that the minimum weight limit is achieved.

28.2.2 Lead Ballast

- (a) If lead ballast is required to achieve the minimum weight for the required class it can only be fitted to the seat.

- (b) Each lead weight (not exceeding 5Kg in weight) must be secured to the seat using two 8mm bolts fitted with lock nuts and 20mm minimum O.D. washers.

28.2.3 Kart Numbering

- (a) Kart numbers must be displayed on all four sides of the kart (Nassau panel, side pods and rear bumper).
- (b) All kart numbers must be clearly legible at all times (plain font and background only).
- (c) All kart numbers must be using class allocated colours for numbers and backgrounds (See Appendix E).
- (d) On-board cameras must not block the view of kart numbers.
- (e) Novice drivers must use black number plates with white numbers for a duration of 6 TKC Championship events.

28.2.4 Bumpers

- (a) All Karts must have front and rear bumpers and side pods fitted to the satisfaction of the scrutineers.
- (b) Quick connect front bumpers are mandatory for all senior classes.
- (c) Drop down nose cones are mandatory for all classes except Bambino.
- (d) The front fairing (must be installed with the approved installation kit) must remain in the correct position at any time of a competition, as described in the Technical Drawing CIK / FIA No. 2c (See Appendix F).

APPLICATION OF THE PENALTY:

A 5 second penalty is applicable on ascertainment of the Officials (Clerk of Course, Judge of Fact, Chief Scrutineer), when passing the finish line and entering parc-ferme to the weighing scale that the fairing is not in its original position. The penalty is final and no appeal allowed. The penalty must be notified to the Driver on entering parc-ferme. The COC and TKC Officials are informed and penalties are instantly applied. If a driver has been witnessed by the CoC, Judge of Fact of intentionally causing the detachment of another Driver's front fairing through brake testing or otherwise he/ she will be penalised. In this case the competitor with the dropped bumper will not receive the penalty. It is prohibited for drivers/entrants to re-attach the front fairing, either on the track, on the recovery vehicle or in the finish area, a breach of this rule shall result in the exclusion of the Driver from Heat 1, Heat 2 or Final. Any modification from the CIK / FIA homologated fixing system or one of its components, is subject to disqualification of the driver from the event, with no appeal allowed.

28.2.5 Brakes

- (a) An efficient braking system is mandatory on all karts and will be checked at scrutineering.
- (b) Master cylinders and associated hydraulic pipe work must be securely fitted to the kart and must be located in a position that minimises the risk of accidental impact or damage.
- (c) Secondary brake cable linkages of a suitable diameter, fitted between the master cylinder and brake pedal, are compulsory on all karts.
- (d) The use of drum brake systems is not permitted.
- (e) With the exception of the 125 KZ gearbox class, the use of front brake systems is prohibited.
- (f) The use of brake disc protectors is mandatory for all senior classes of kart.

28.2.6 Chain Guard

A chain guard is compulsory and must be an effective protection over the top of the exposed chain and rear sprocket and extend at least to the lower plane of the rear axle down a line at least level with the centre of both front and rear sprockets.

28.2.6 Transponders

- (a) It is compulsory for all competitors to have a working AMB TranX160/MyLaps X2 transponder (or equivalent) fitted to their kart for the purposes of lap timing and lap recording in all practice sessions and races.
- (b) Transponders must be securely fitted to the back of the seat or seat struts and in no other position.
- (c) It is the driver's responsibility to ensure that his/her transponder is being detected by the timing system.

- (d) Transponders not fitted or failing to operate; resulting in a nil lap time will result in no finishing position being awarded.
- (e) There will be a limited supply of transponders available for hire.
- (f) If renting a transponder from TKC, rental fee must be paid before use. Rented transponders must be returned to TKC immediately once racing has concluded or a fee will be applied.

28.2.8 Rear Red Light

A fully functioning, rearward facing, red light must be fitted securely on all karts. The light must be illuminated in wet and dark weather conditions under the instruction of the CoC. The rear red light must be set to **solid red light and not flashing mode**. Failure to adhere to this requirement will result in the driver being penalised (see 'Penalties' section, Appendix C).

28.2.9 Data logging /Telemetry

The use of data loggers, e.g. Mychron 5, Uniporo, Alfano, is permitted to collect on-track data for later analysis. Additional original equipment sensors may be fitted in accordance with manufacturer's recommendation and fitting instructions. This is limited to GPS, brake/throttle, speed and steering. The use of an external battery source is permitted but must be secured beneath the nassau panel in a protective casing. Two way or transmission of data from the kart whilst in motion is strictly prohibited.

28.2.10 Cameras

The use of action cameras is permitted but the unit must be fitted using an appropriate manufacturer type fitting, or as approved by scrutineering. The placement of the camera should not block the race number of the kart. **It is not permitted to fit camera to your race helmet.**

28.2.11 Radio communication

The use of any radio/ telecommunication system between a driver on the track and any other body is strictly prohibited.

28.3 Engine

All engines must at all times conform in all aspects with the MSUK / MSA / FIA homologation fiche (as applicable). Compliance with the fiche may be checked at any time during an event.









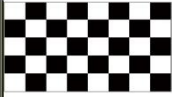

Engines may be selected at random to be sent to an engine builder chosen by the TKC committee for confirmation that they adhere to current MSUK / MSA / FIA homologation fiche (as applicable). Failure to permit your engine be sent for checks will result in exclusion from the event.

28.3.1 Procedure for engine scrutiny

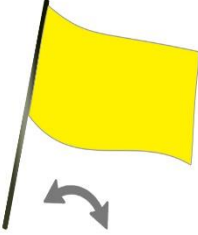
- (a) If an engine is selected for further scrutiny the race result is postponed and will be confirmed when the engine's legality is confirmed.
- (b) If selected for further scrutiny, engines will be required to be removed from the kart in parc-ferme and presented for inspection in their complete state, immediately after the meeting has finished. The responsibility of removing the engine is that of the competitor concerned. Inspection of the engine exhaust system may also be requested.
- (c) Engines that are selected for further scrutiny will be placed into an engine box in the presence of competitor/guardian. The engine box containing the engine will be sealed by head scrutineer.
- (d) The competitor/competitor's guardian will be then required to sign an engine conformity agreement. This agreement states that if the engine does not conform to current MSA / MSUK / FIA homologation fiche the competitor must pay the fee for the engine technical check fee and will be disqualified from the event. If the engine is legal and matches current MSA / MSUK / FIA homologation fiche, TKC will pay the fee.
- (e) Where applicable, engines must be sealed to prevent modification. The engine seal number will be recorded at scrutineering and must correspond with the number listed on the engine's logbook.
- (f) The seal number (where applicable) is required on the scrutineering report form as a means of identification in the event of further inspection and for spot checking during competition.

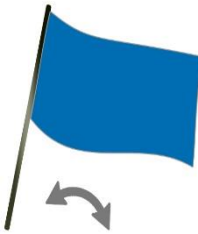
- (g) If the replacement engine's seal number has not been listed on the scrutineering report form then the replacement engine, if it is required for use, must be presented to the Scrutineers to enable the seal number to be recorded.
- (h) Engine components may also be marked or sealed to provide a means of identification for further engine inspection or for spot checking during competition.
- (i) If an engine/engine component, that has been marked/sealed or recorded in anyway, is required to be replaced, it must first be presented to the Scrutineers for inspection, except in the case of a replacement engine, which has already been recorded on the scrutineering report form.
- (j) The maximum number of engines permitted for use during a race day is 2.
- (k) The internal working surfaces of clutch components must remain dry and free of grease or lubricant or any additional substance. It is prohibited to alter the physical dimensions of the clutch components in any way. Particular care must be taken when lubricating the chain and bearings to ensure that no lubricant enters the clutch. Clutches may be inspected before and/or after a race. If any contaminant is found on a clutch in the course of a pre-race inspection, the driver of the kart involved will immediately be excluded from participation in that race.
- (l) Filing, grinding, polishing, surface treating, machining or lightening any component is forbidden.
- (m) The use of high-octane fuel or performance enhancing fuel additives is strictly forbidden.

Appendix A - Karting Flags

Flag	Explanation	Flag	Explanation
 Black	Displayed to the driver at the start/finish line. The driver has been disqualified and must continue at race pace and leave the track at the end of the lap.	 Chequered	End of practice session, or race.
 Red	Cease driving at racing speed, proceed slowly (no overtaking), with caution to the start line as instructed by the Track Marshals. Drivers must always obey Marshal's instructions, be prepared to stop if the track is blocked.	 Green	Displayed to the drivers at the start/finish line to start all heats and finals. All clear at end of the danger area controlled by Yellow flags.
 Yellow	Danger, slow down ensuring the full control of the kart is kept. No overtaking.	 Waved Yellow	Great Danger, slow down considerably. Be prepared to suddenly deviate from racing line or take evasive action or stop. No overtaking.
 Blue	A faster competitor is following close behind.	 Waved Blue	A faster competitor is trying to overtake.
 Black / White	Displayed to the driver at the start/finish line. Warning to driver that their behaviour is suspect and that they may receive the Black flag on further reports.	 Black / Orange Circle	Displayed to the driver to inform him/her of apparent mechanical failure or fire which may not be obvious to the driver. The kart must return to pits at the end of the lap.
 Yellow/Red	Slippery surface ahead.		

Appendix B - Tyre Specifications

Class	Dry Tyres	Wet Tyres
Bambino Comer	Le Cont MSA All-Weather tyre (Limited to 1 set per round)	Le Cont MSA All-Weather tyre (Limited to 1 set per round)
Bambino IAME	Heideneau T-Race Green (Limited to 2 sets for 2023 Championship)	Heideneau WH1
Iame Cadet	Maxxis T-Max-MK-DRY1 (Front 10*3.6*5; Rear 11*5.1*5) (Limited to 3 set for the year)	T-Max-MK-WET1 (Front 10*3.6*5; Rear 11*4.5*5)
Restricted Cadet	Dunlop LS2/SL3 (Front 10*3.6*5; Rear 11*5.1*5) (Limited to 3 sets for 2023 Championship)	Dunlop KT3 (Front 10*3.6*5; Rear 11*4.5*5)
Junior Max	MOJO D2 / D2XX (Front 10.0 x 4.50-5; rear 11.0 x 7.10-5) (Limited to 1 set per round)	MOJO W5 / MOJO W2 (Front 10.0 x 4.50-5; Rear 11.0 x 6.00-5) (limited to 2 sets per event)
Junior X30	Komet K2H (Limited to 1 set per round)	Komet K1W (limited to 2 sets per event)
Senior X30	Komet K2M (Limited to 1 set per round)	Komet K1W (limited to 2 sets per event)
Rotax Senior Max (165)	MOJO D5 (Front 10.0 x 4.50-5; Rear 11.0 x 7.10-5) (Limited to 1 set per round)	MOJO W5 / MOJO W2 (Front 10.0 x 4.50-5; Rear 11.0 x 6.00-5) (limited to 2 sets per event)
Rotax Senior Max (180)	MOJO D5 (Front 10.0 x 4.50-5; Rear 11.0 x 7.10-5) (Limited to 1 set per round)	MOJO W5 / MOJO W2 (Front 10.0 x 4.50-5; Rear 11.0 x 6.00-5) (limited to 2 sets per event)
Gearbox / 125 KZ2	Open choice (Limited to 1 set per round)	Open choice (Limited to 1 set per round)
Super Pro	Maxxis SLR or Maxxis T4	Open choice

Appendix C - Example Offences and Subsequent Penalties

Offence	Penalty
Driver Sign on / check in	
Driver not signed on for meeting	Disqualification from meeting
Late sign on infringement	€50 Fine (no participation until fine is paid)
Driver's Briefing	
Driver's briefing – failure to attend	No admittance to track until such time as the driver has been briefed by the CoC or an appointee of the CoC
Driver's briefing – entering track without attending driver's briefing or without being separately briefed by the CoC or an appointee of the CoC	Disqualification from the meeting.
Race Wear	
Failure to wear race suit, boots, gloves, helmet, rib protector (where specified), neck brace (where specified)	No admission to track through to disqualification from session
Failure to obey instructions / flags	
Failure to obey instructions of Officials or Marshals	Grid position penalty through to disqualification from meeting
Failure to comply with Yellow or Blue Flags	3 place penalty through to disqualification from race
Failure to comply with Mechanical Failure Flag or Black Flag	Disqualification from meeting
Failure to present kart, engine or apparel to the CoC or scrutineers on request	Disqualification from meeting. Forfeit all points already gained at that meeting.
Dummy Grid	
Starting a kart in the dummy grid area whilst on a trolley or Lifting the kart on the dummy grid while the engine is running.	Placed to the back of the grid.
Lifting the rear of a Bambino or Cadet kart whilst the engine is running.	Placed to the back of the grid.
Driving	
On approaching the start line all karts must remain in their grid row until they pass Start/finish line.	A penalty of 5 seconds
Avoidable kart contact on track (e.g. pushing or banging)	3 place penalty through to disqualification from meeting
Dangerous or over aggressive driving	Disqualification from session through to multiple race ban
Gaining an unfair advantage	5 seconds or 1 lap penalty
Starting infringement	Grid placement penalty or time/placement penalty applied to finishing results

Offence	Penalty
Underweight	
Minimum weight infringement	Disqualification from that heat or final .
Behaviour	
Verbal / Physical abuse by a competitor towards a race Marshal, Official, Organiser or any other event participant	Fine and/or race ban through to suspension or expulsion from the Club (at the Committee's discretion).
Verbal / Physical abuse by any parent, guardian, family member, associate or crew member towards a race Marshal, Official, Organiser or any other event participant	Fine and/or race ban through to suspension or expulsion of competitor and relevant associates from Club (at the Committee's discretion).
Standing on top of any vehicle, or vehicle tailgate or other portable raised platform for spectating or other purposes.	Exclusion of the driver / entire team and any other driver associated in any manner with those involved in the breach from the event.
Outside assistance given to a driver at any point during the race (For Bambino and Cadet classes, the CoC may grant an exception to this rule at his sole and absolute discretion).	Disqualification from that race.
More than 1 person accompanying driver onto the dummy grid / track / parc ferme.	3 place penalty through to disqualification from race
Scrutiny	
Engine non-conformance	Disqualification from meeting through to multiple race ban
Tyre infringement (including incorrect type, chemical treatment, incorrect use)	Disqualification from relevant race or entire meeting or exclusion from all races for a period of 1 year.
Equipment including chassis, tyres and engines do not conform in all respects to the data on the scrutineering document.	Driver disqualified from the relevant heat or final.
Front Fairing (Dropped nose cone)	
Any modification from the CIK / FIA homologated fixing system or one of its components	Disqualification of the driver from the event, with no appeal allowed.
Driver/entrant attempting to re-attach the front fairing, either on the track, on the recovery vehicle or in the finish area.	Disqualification of the Driver from Heat 1, Heat 2 or Final.
Front fairing not in its original position when passing the finish line and entering parc ferme. The penalty is final and no appeal allowed	5 second penalty. The penalty is final and no appeal allowed

Appendix D – Kart Class Information

Bambino Comer

- Ages 5 – 8 Minimum of 5 year old on the date of the event. If a competitor has competed in at least one championship race that year but turn 9 before the end of the championship they may complete the championship in that class
- Engine: Comer C50 (tagged).
- Engine spec: Motorsport UK / MSA. Find spec here [Comer Bambino](#) No inlet restrictor required.
- Standard air filter
- Carb: Standard Dell'Orto SHA 12/14 L as per the current homologation fiche. Standard exhaust with no modifications
- Sprocket: 10 tooth front sprocket / 80 tooth rear sprocket (78 tooth for Galway)
- Weight: 71kg
- Tyres: Le Cont MSA All-Weather tyres (1 x set per race event permitted) Minimum tread depth is 1mm at any point across the tyre or at any point picked by the scrutineer
- Neck brace & rib protector mandatory
- Kart Numbers: Yellow background / Black number
- Novice must wear high-vis armband, novice number plates and start at back of the grid for both heats.

Bambino IAME

- Ages 6 – 8 Minimum of 6 year old on the date of the event. If a competitor has competed in at least one championship race that year but turn 9 before the end of the championship they may complete the championship in that class
- Engine: IAME M1
- Engine spec: [IAME Bambino](#)
- Sprocket: 10 or 11 tooth front sprocket. 80 tooth rear sprocket
- Carb: For Iame M1 Bambino the Tillotson HS-325-A as per the current homologation fiche. The carburettor must remain unmodified and conform in all aspects to the official homologation fiche.
- The inlet spacer Part Number EG31011 must be in place at all times as must the 11.5mm exhaust spacer part no EH20511.
- Weight: 74kg
- Tyres: **Dry tyres:** Heideneau T-Race Green (2 sets for 2023 Championship) **Wets:** Heideneau WH1
- Neck brace mandatory & rib protector mandatory
- Kart Numbers: Yellow background / Black number
- Novice must wear high-vis armband, novice number plates and start at back of the grid for both heats.

Restricted Cadet

- Ages 8 – 10 Can compete on year of 8th birthday. If a competitor has competed in at least one championship race that year but turn 11 before the end of the championship, they may complete the championship in that class
- Engine: IAME Parilla Gazelle 60cc
- Chassis : Either 900 or 950 can be used
- Spec: IAME Cadet Use of exhaust restrictor **will** be required.
- It will not be possible to use Shell M oil. The oil to be used is ELF 909 HTX.
- Weight: 95kg
- Tyres: **Dry tyres:** Dunlop LS2/SL3 (Limited to 3 sets for 2023 Championship) **Wets:** Dunlop KT3
- Neck brace strongly recommended / Rib protector mandatory.
- Kart Numbers: Yellow background / Red number
- Drop nose cones mandatory.

- Novice must wear high-vis armband, novice number plates and start at back of the grid for both heats.

IAME Cadet

- Ages 8 – 12 Can compete on year of 8th birthday. If a competitor has competed in at least one championship race that year but turn 13 before the end of the championship they may complete the championship in that class
- Engine: IAME Parilla Gazelle 60cc
- Chassis : Either 900 or 950 can be used
- Spec: [IAME Cadet](#) Use of exhaust restrictor will not be required.
- It will not be possible to use Shell M oil. The oil to be used is ELF 909 HTX.
- Weight: 105kg
- Tyres: **Dry tyres:** Maxxis T-Max-MK-DRY1 (Limited to 3 sets for 2023 Championship)
Wets: Maxxis T-Max-MK-WET1
- Neck brace strongly recommended / Rib protector mandatory.
- Kart Numbers: Yellow background / Black number
- Drop nose cones mandatory.
- Novice must wear high-vis armband, novice number plates and start at back of the grid for both heats.

Junior Max

- Ages 12 - 16 Can compete on year of 12th birthday. If a competitor has competed in at least one championship race that year but turn 17 before the end of the championship they may complete the championship in that class
- Engine: Rotax Junior Max
- Engine spec: Motorsport UK / MSA. Find spec here [Rotax Fiche \(filesusr.com\)](https://filesusr.com)
- ECU type: Junior ECU (Part no: 666813)
- Weight: 148kg
Tyres: **Dry tyres:** MOJO D2 / D2XX (Front 10.0 x 4.50-5; rear 11.0 x 7.10-5) 1 x set per race event permitted
Wet tyres: MOJO W5 / MOJO W2 (Front 10.0 x 4.50-5; Rear 11.0 x 6.00-5) (2 sets per event)
MOJO W2 tyres can only be used as full sets and not mixed with MOJO W5 wet tyres.
- Drop nose cones mandatory.
- Kart Numbers: Red background / White number
- Neck brace strongly recommended / Rib protector mandatory.
- Novice must wear high-vis armband, novice number plates and start at back of the grid for both heats.

Junior IAME X30

- Ages: 11-15 Can compete on year of 11th birthday. If a competitor has competed in at least one championship race that year but turn 16 before the end of the championship they may complete the championship in that class
- Engine: IAME X30 Find spec here: [Junior x30](#) Carb: [IAME x30 Carb](#)
- Exhaust: [Junior x30 Exhaust](#)
- Weight: 145kg
Tyres: **Dry tyres:** Komet K2H (1 x set per race event permitted)
Wet tyres: Komet K1W (2 sets per event)
- Drop nose cones mandatory.
- Kart Numbers: Green background / White number
- Neck brace strongly recommended / Rib protector mandatory.
- Novice must wear high-vis armband, novice number plates and start at back of the grid for both heats.

Senior IAME X30

- Age 15+ Can Compete on year of 15th birthday
- Weight: 161kg
- Engine: IAME X30
- Engine spec: [IAME x30](#)
- Changes from 2019: [IAME x30 Changes 2019](#)
- Carb: [IAME x30 Carb](#)
Tyres: **Dry tyres:** Komet K2M (1 x set per race event permitted)
Wets: Komet K1W (2 sets per event)
- Drop nose cones mandatory.
- Rib protector strongly recommended (mandatory for drivers under the age of 18)
- Kart Numbers: Yellow background / Black number
- Novice must wear high-vis armband, novice number plates and start at back of the grid for both heats.

Rotax Senior Max (165)

- Age 15 + Can Compete on year of 15th birthday
- Engine: Rotax Max 125
- Engine spec: Motorsport UK / MSA. Find spec here [Rotax Fiche \(filesusr.com\)](#)
- ECU type: Senior ECU (Part no: 666815)
- Weight: 165kg
Tyres: **Dry tyres:** MOJO D5 (Front 10.0 x 4.50-5; Rear 11.0 x 7.10-5) 1 x set per race event permitted
Wets: MOJO W5 / MOJO W2 (Front 10.0 x 4.50-5; Rear 11.0 x 6.00-5) (2 sets per event)
MOJO W2 tyres can only be used as full sets and not mixed with MOJO W5 wet tyres.
- Drop nose cones mandatory.
- Rib protector strongly recommended (mandatory for drivers under the age of 18)
- Kart Numbers: Blue background / White number
- Novice must wear high-vis armband, novice number plates and start at back of the grid for both heats.

Rotax Senior Max (180)

- Age 16 + Can Compete on year of 15th birthday
- Engine: Rotax Max 125
- Engine spec: Motorsport UK / MSA. Find spec [Rotax Fiche \(filesusr.com\)](#)
- ECU type: Senior ECU (Part no: 666815)
- Weight: 180kg
Tyres: **Dry tyres:** MOJO D5 (Front 10.0 x 4.50-5; Rear 11.0 x 7.10-5) 1 x set per race event permitted
Wets: MOJO W5 / MOJO W2 (Front 10.0 x 4.50-5; Rear 11.0 x 6.00-5) (2 sets per event)
MOJO W2 tyres can only be used as full sets and not mixed with MOJO W5 wet tyres.
- Drop nose cones mandatory.
- Rib protector strongly recommended (mandatory for drivers under the age of 18)
- Kart Numbers: Green background / White number
- Novice must wear high-vis armband, novice number plates and start at back of the grid for both heats.

Gearbox / 125 KZ2

- Age 15 + Can Compete on year if 15th birthday
- Weight: 180kg
- Engine: Open Choice
- Tyres: **Dry tyres:** Open Choice **Wets:** Open choice 1 x set per race event permitted
- Drop nose cones mandatory.

- Rib protector strongly recommended.
- Kart Numbers: Green background / White number
- Novice must wear high-vis armband, novice number plates and start at back of the grid for both heats.

Super Pro

- Age 16 + Can Compete on year if 16th birthday
- Weight: 195kg
- Engine: GX620 series engine. Pull or electric start only. Find spec here: [Super Pro](#)
- Tyres: **Dry tyres:** Maxxis SLR or Maxxis T4 **Wet tyres:** Open choice
- Front bumper must be detachable. From 2022 onwards, the front bumper must be drop-down as per other classes.
- Rib protector strongly recommended (mandatory for drivers under the age of 18)
- Kart Numbers: Red background / White number
- Novice must wear high-vis armband, novice number plates and start at back of the grid for both heats.

Appendix E – TKC Number Plate Regulations

Drivers must all display the correct colour numbers and plates for their class on all four sides of the kart. Stickers must be on rear of kart, front nassau panel, and on both side pods.



Novice Driver



Comer Bambino



IAME Bambino



Restricted Cadet



IAME Cadet



Super Pro



Junior Max



Junior x30



Senior x30



Senior Rotax 165
(non-evo)



Senior Rotax 165 (open)



Senior Rotax 180
(non-evo)



Senior Rotax 165 (open)



Gearbox

Appendix F – Front Fairing, Technical Drawing 2c

DESSINS TECHNIQUES
TECHNICAL DRAWINGS

DESSIN TECHNIQUE N°2c

TECHNICAL DRAWING No. 2c

Kit de montage de carénage avant

Front fairing mounting kit

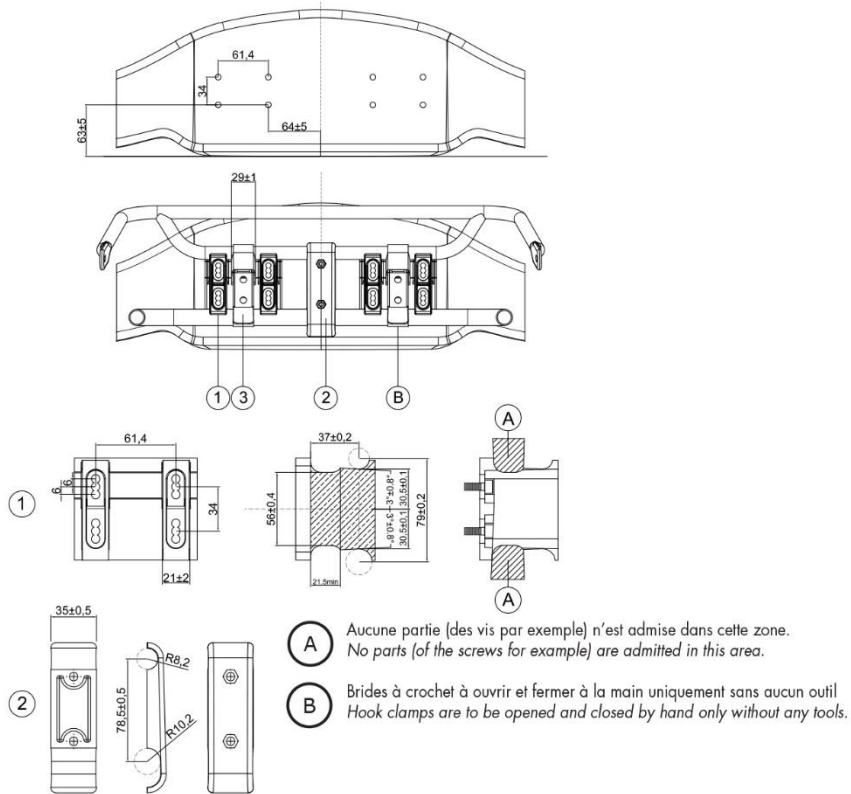

Il n'est permis de fixer le carénage avant sur le kart qu'au moyen du kit de montage de carénage avant. Aucun autre dispositif n'est autorisé. Le carénage avant doit pouvoir reculer librement en direction du châssis sans aucune obstruction d'une partie quelconque pouvant limiter le mouvement.

Les pare-chocs avant (tubes inférieur et supérieur) doivent être rigidement fixés au châssis et présenter une surface lisse. Toute intervention mécanique ou autre destinée à augmenter la friction des pare-chocs avant est strictement interdite.

Dans tous les cas, un espace de 27 mm minimum doit être prévu en tous points entre les pare-chocs avant (tubes inférieur et supérieur) et le carénage avant.

Définition «Kit de montage de carénage avant»

1. Kit de support de montage pour carénage avant (2 pièces + 8 vis au total).
2. Support de pare-chocs avant (2 demi-coques + 2 vis au total).
3. Brides à crochet réglables (les 2 pièces doivent être fabriquées en métal).

Le logo de la CIK et le numéro d'homologation doivent être estampillés sur chaque pièce.

1. Kit de support de montage pour carénage avant (les 2 pièces doivent être fabriquées en plastique).
2. Support de pare-chocs avant (les 2 demi-coques doivent être fabriquées en plastique).

It is only permitted to fix the front fairing onto the kart using the front fairing mounting kit. No other device is authorised. It must be possible for the front fairing to move freely back in the direction of the chassis without any obstruction from any part that may restrict movement.

The front bumpers (lower and upper tube) must be rigidly connected with the chassis and must have a smooth surface. Any mechanical work or other intervention to maximize the friction of the front bumpers is strictly forbidden.

There must be a clearance at all points between the front bumpers (lower and upper tube) and the front fairing of a minimum of 27 mm at all times.

Definition «Front fairing mounting kit»

1. Mounting bracket kit for front fairing (2 pieces + 8 screws in total).
2. Front bumper support (2 half shells + 2 screws in total).
3. Adjustable hook clamps (the 2 pieces, shall be made of metal).

CIK Logo & Homologation number shall be embossed on each piece

1. Mounting bracket kit for front fairing (the 2 pieces shall be made of plastic).
2. Front bumper support (the 2 half shells shall be made of plastic).

Appendix G: T-Plate Supplementary Regulations:

Classes eligible for trophies and T-Plate Cup:

- Bambino Comer
- Bambino lame
- lame Cadet
- Restricted Cadet
- Junior Max
- Junior X30
- Senior X30
- Rotax 165
- Rotax 180
- Super Pro
- Gearbox

Drivers must be a TKC 2023 paid member and have competed in at least four 2023 TKC Championship rounds in the class they are entered in order to qualify for the TKC T-Plate Title and Perpetual Cup.

A winning driver who is a TKC 2023 paid member but has not competed in at least four 2023 TKC Championship rounds will win a TKC trophy but not the TKC T-Plate Title or Perpetual Cup.

1 x set of tyres permitted for the event.

T-Plate Perpetual Cups will be presented at the TKC Awards Night.